

Les nombres jusqu'à 15

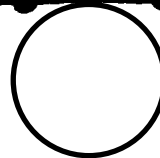

Colorie l'ensemble où il y a plus d'objets.

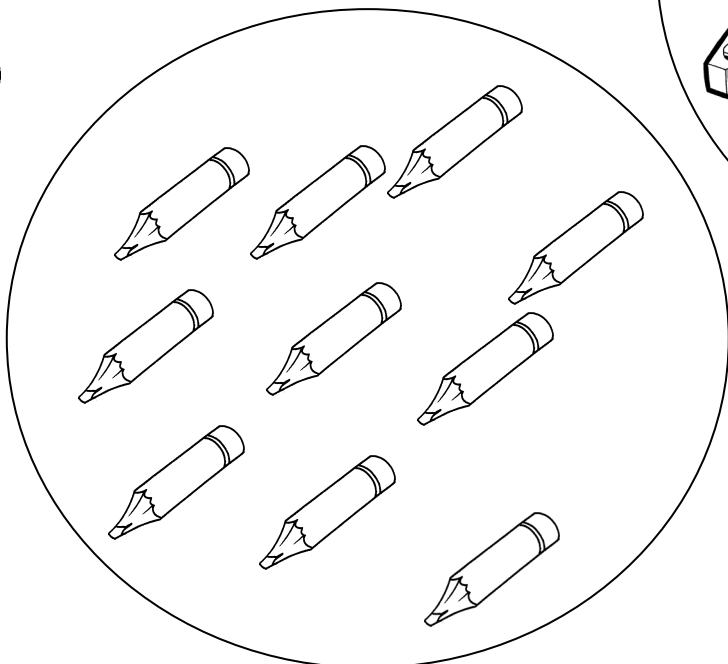
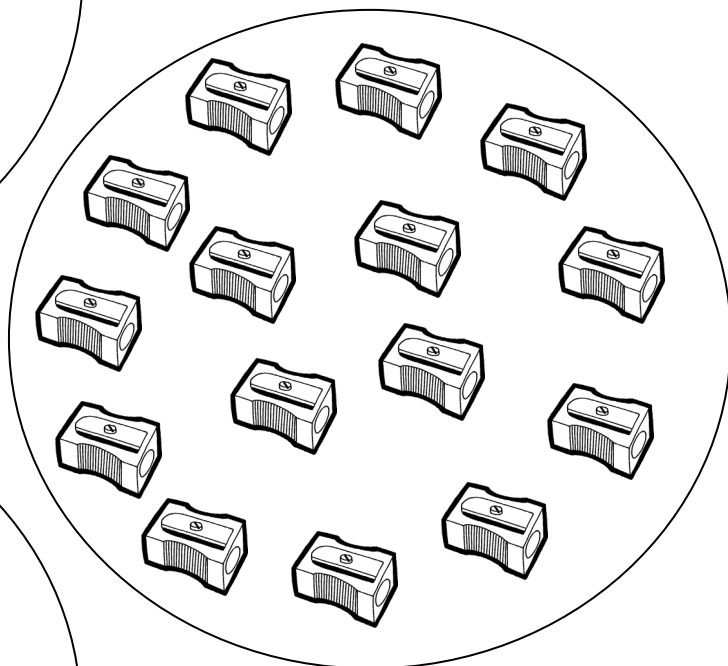
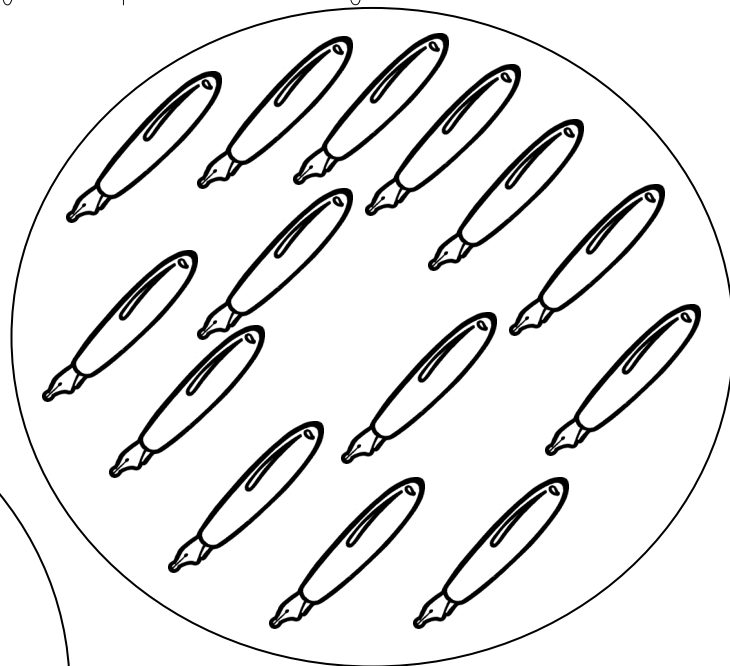
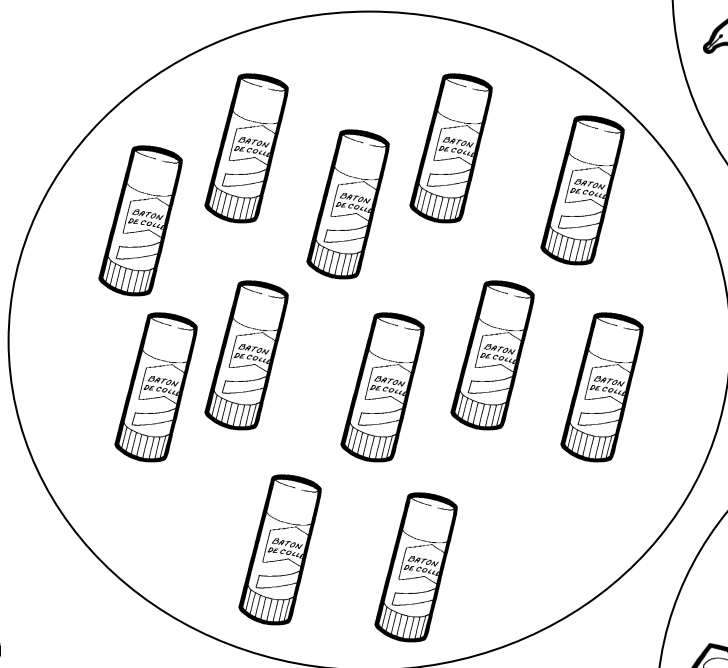

Les nombres jusqu'à 15

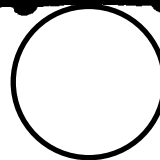

Colorie l'ensemble où il y a le moins d'objets.

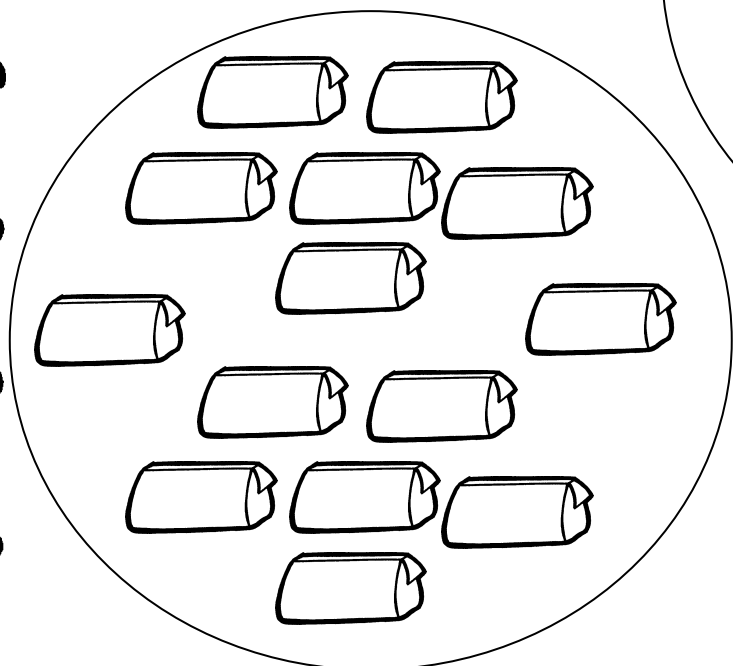
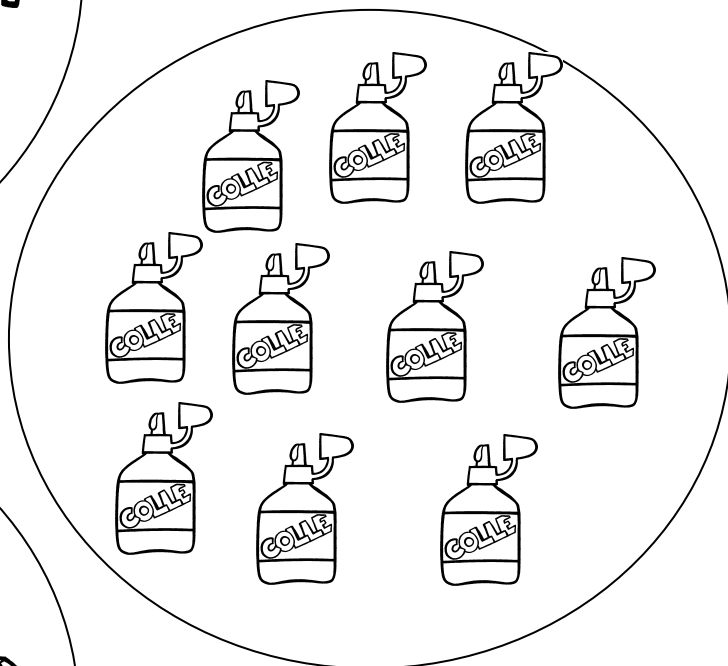
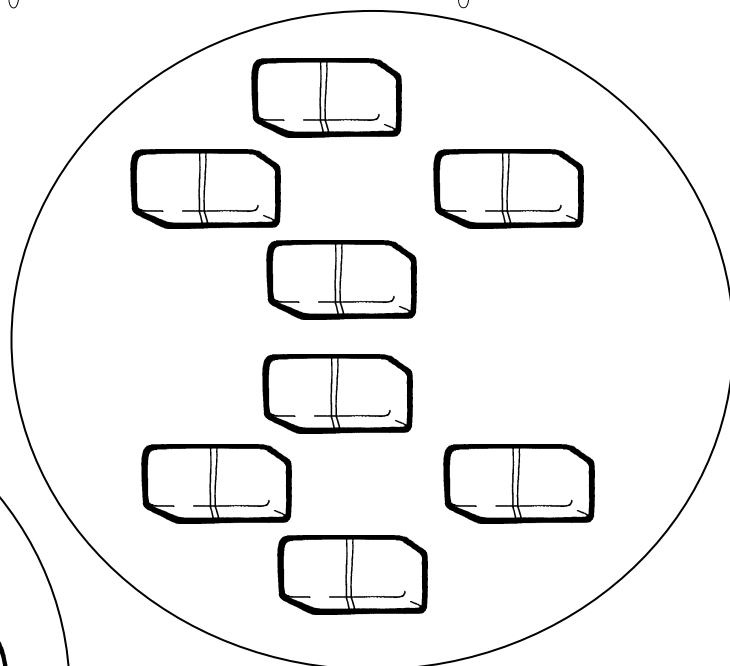
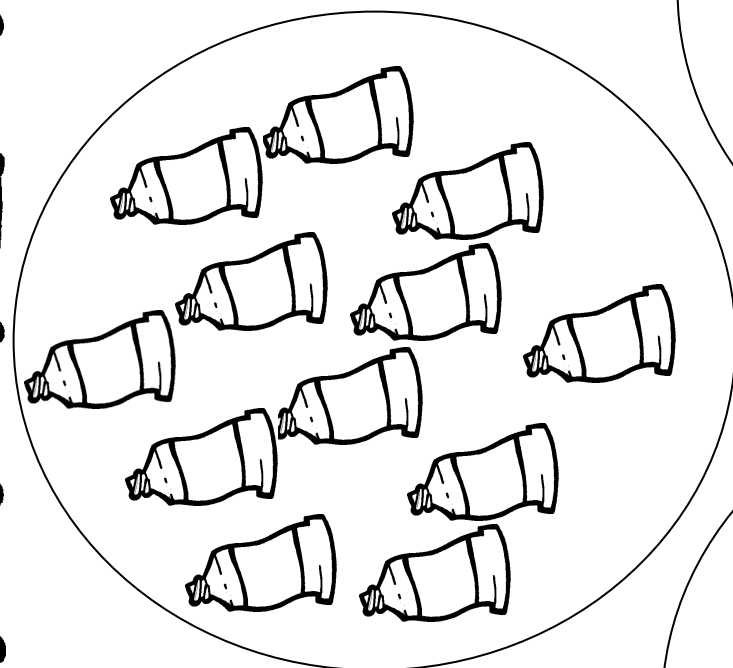

Les nombres jusqu'à 15

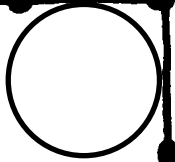

Relie pour que chaque enfant ait un livre et une

mallette

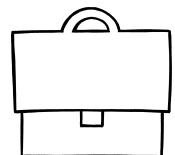
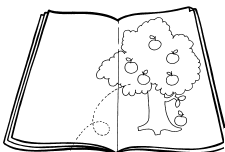
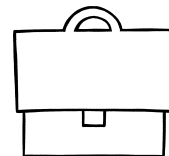
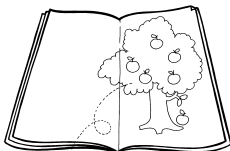
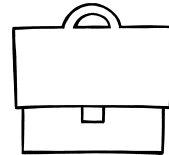
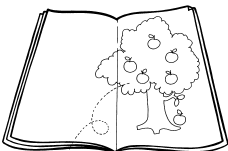
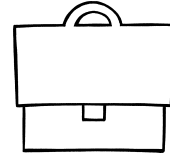
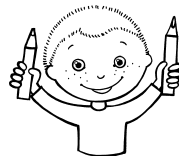
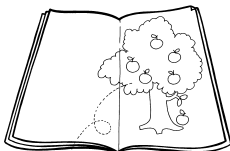
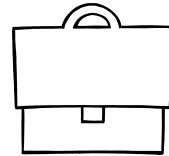
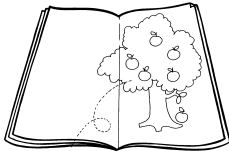
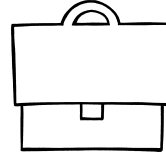
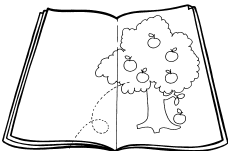
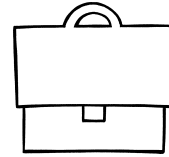
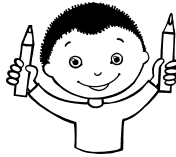
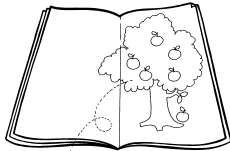
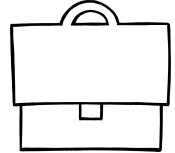
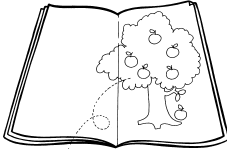
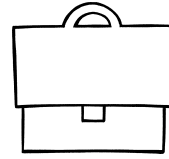
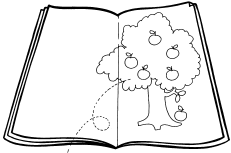

Les nombres jusqu'à 15

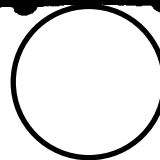

Réalise des paquets de

13 livres.

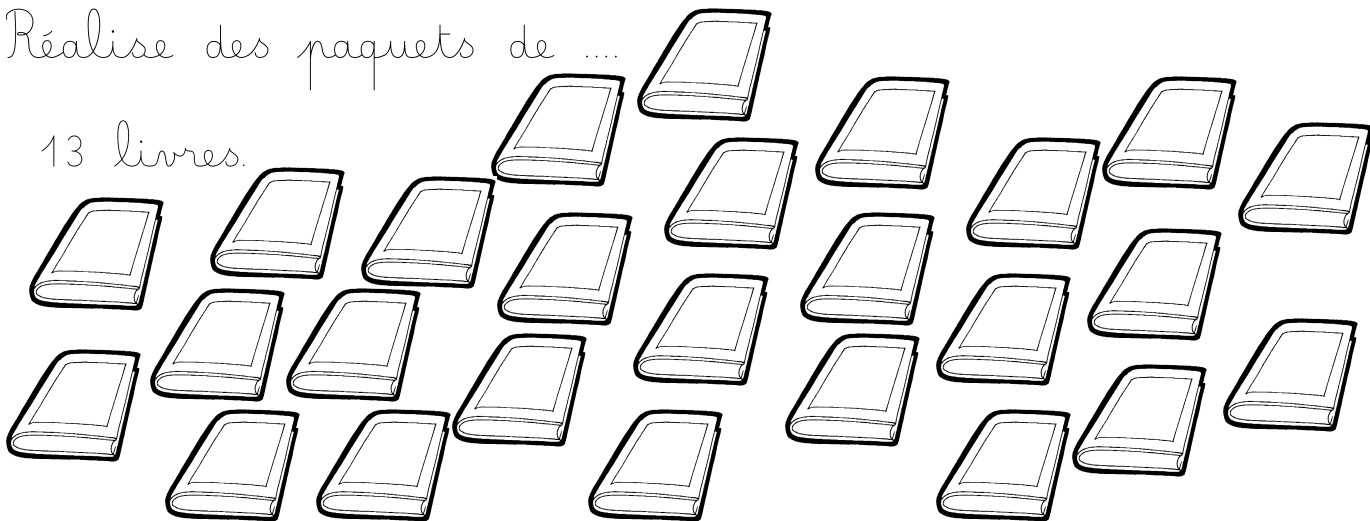

10 crayons.

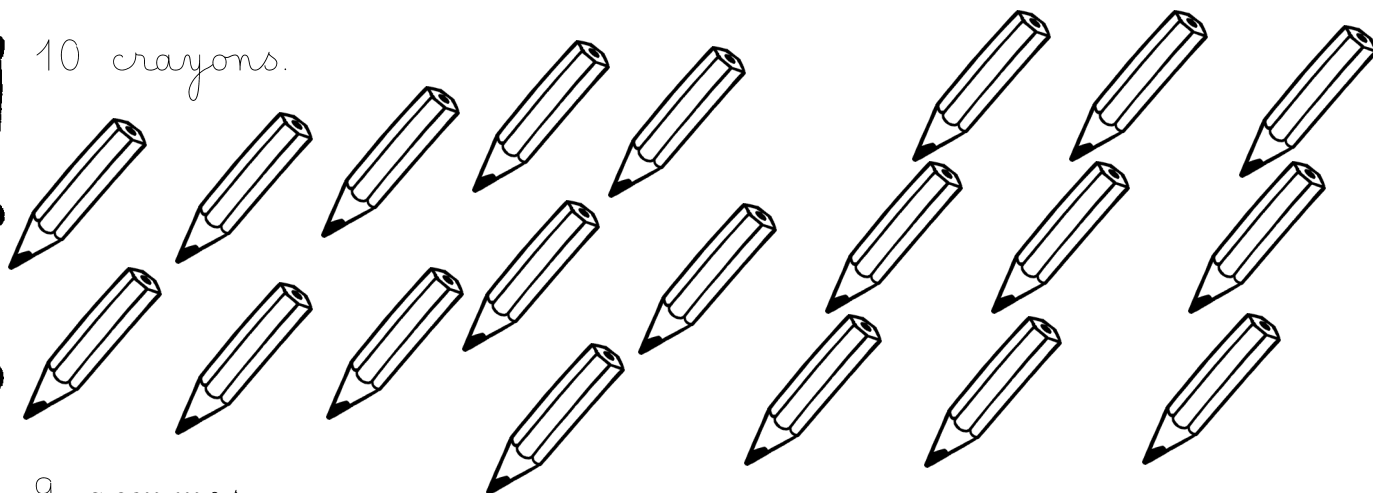

9 gommes.

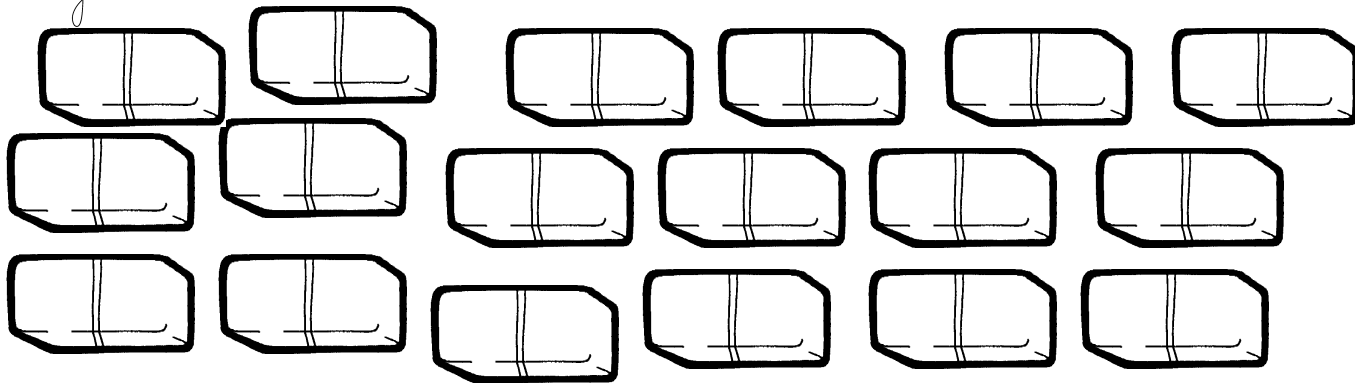

12 plumiers.

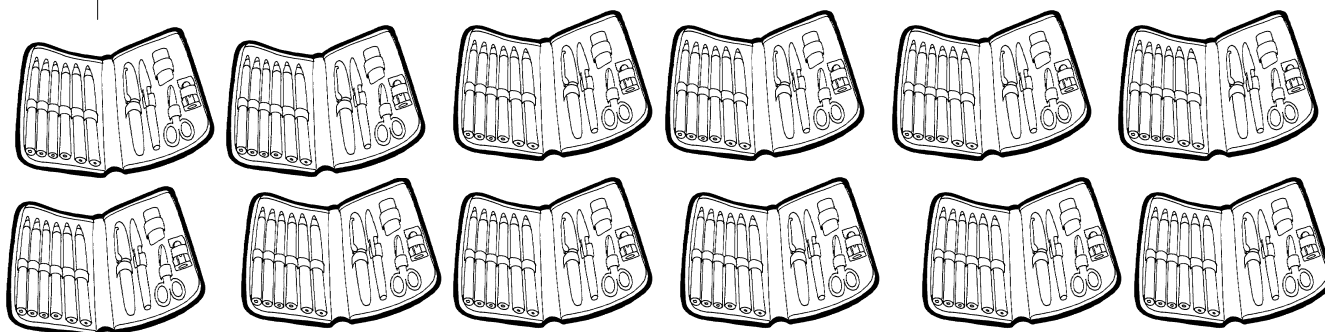

Les nombres jusqu'à 15

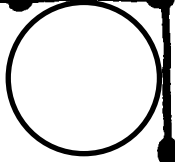

Ajoute ou barre pour avoir 9.

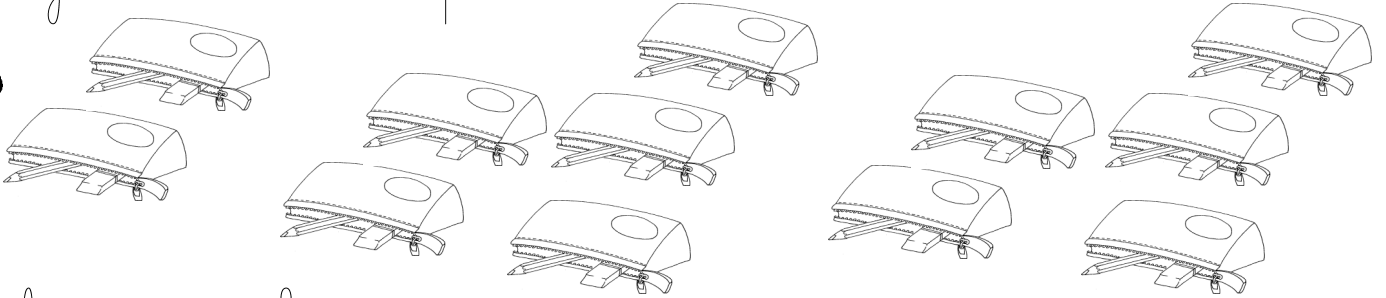

Ajoute ou barre pour avoir 10.

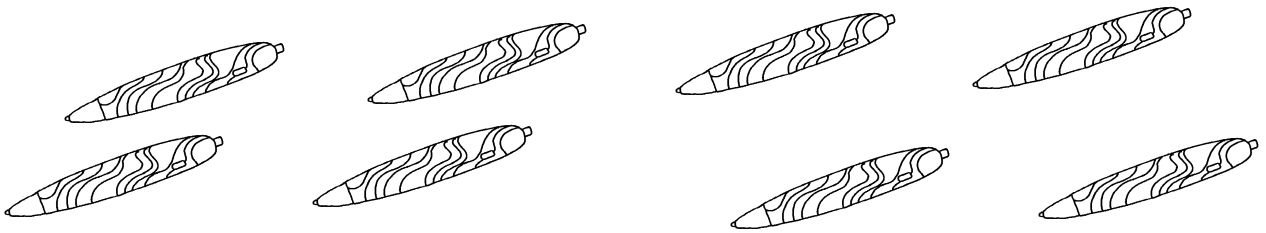

Ajoute ou barre pour avoir 9.

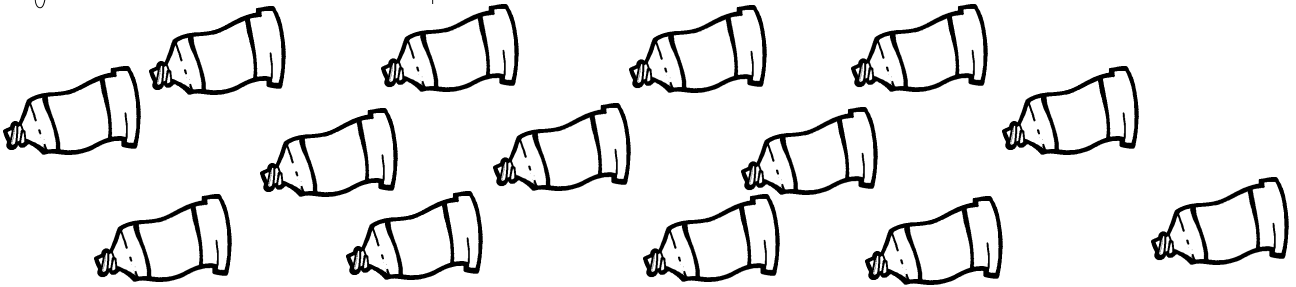

Ajoute ou barre pour avoir 14.

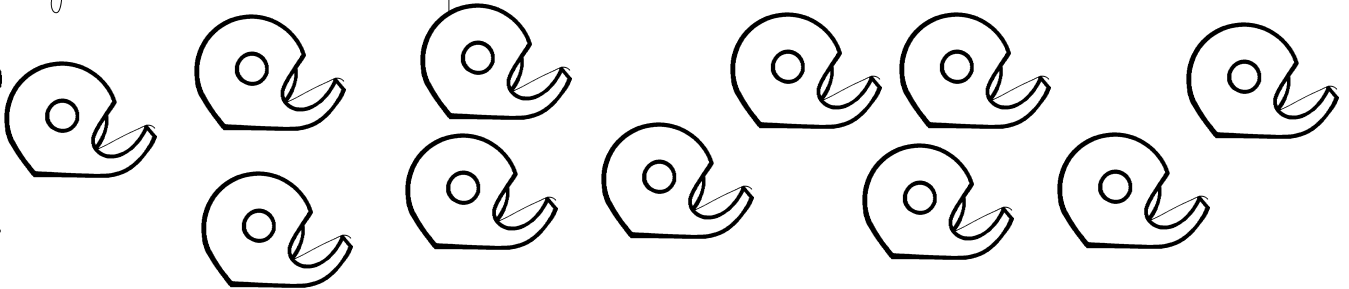

Ajoute ou barre pour avoir 15.

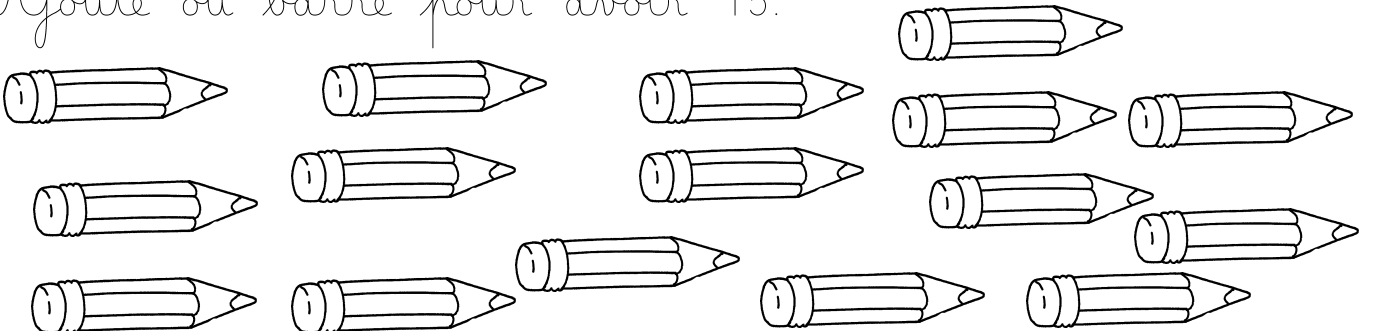

Les nombres jusqu'à 15

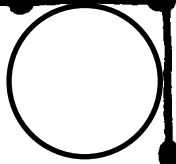

Colorie le 8ème cahier.



Colorie le 10ème plumier.

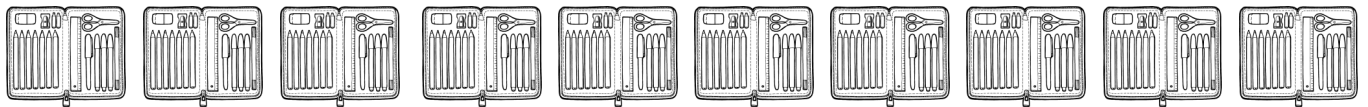

Colorie la 13ème fille.

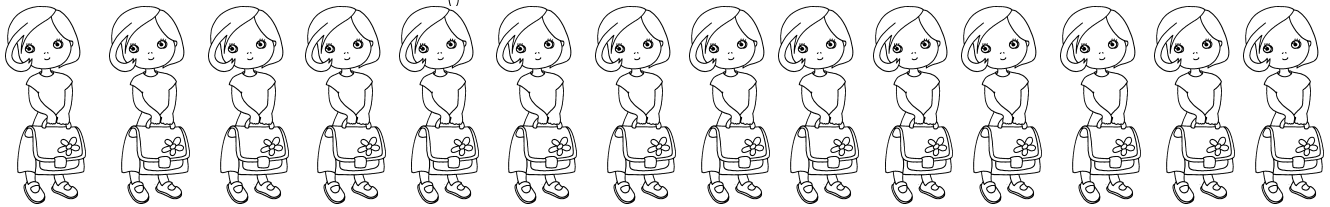

Colorie le 11ème garçon.

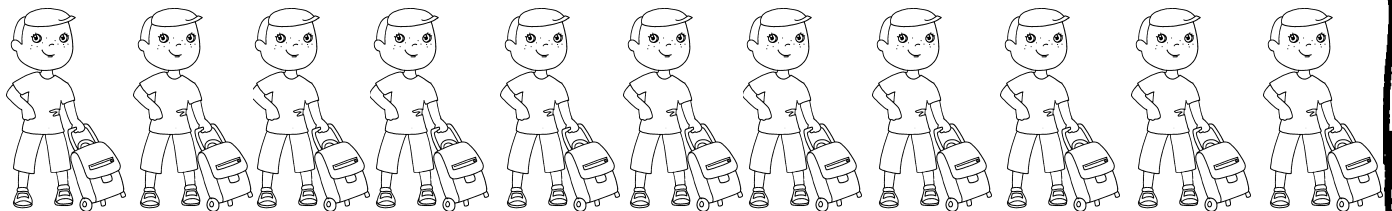

Colorie la 7ème école.



Colorie la 9ème école.



Les nombres jusqu'à 15

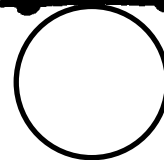

Complète les droites des nombres

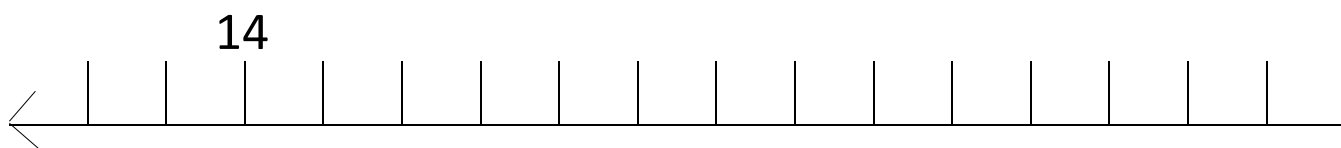
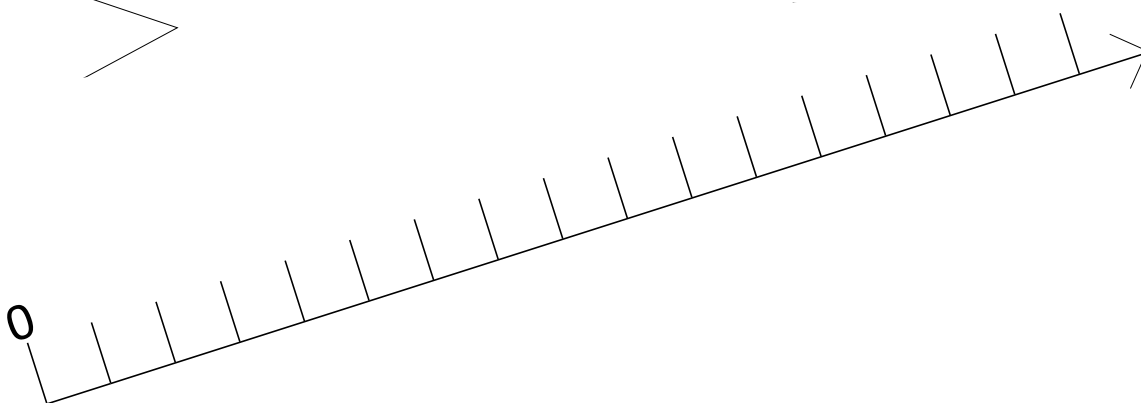
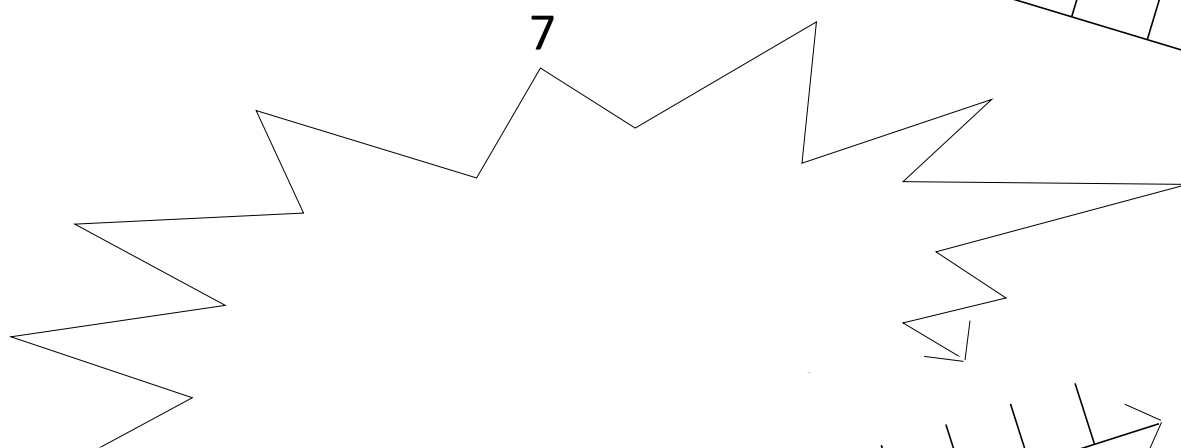
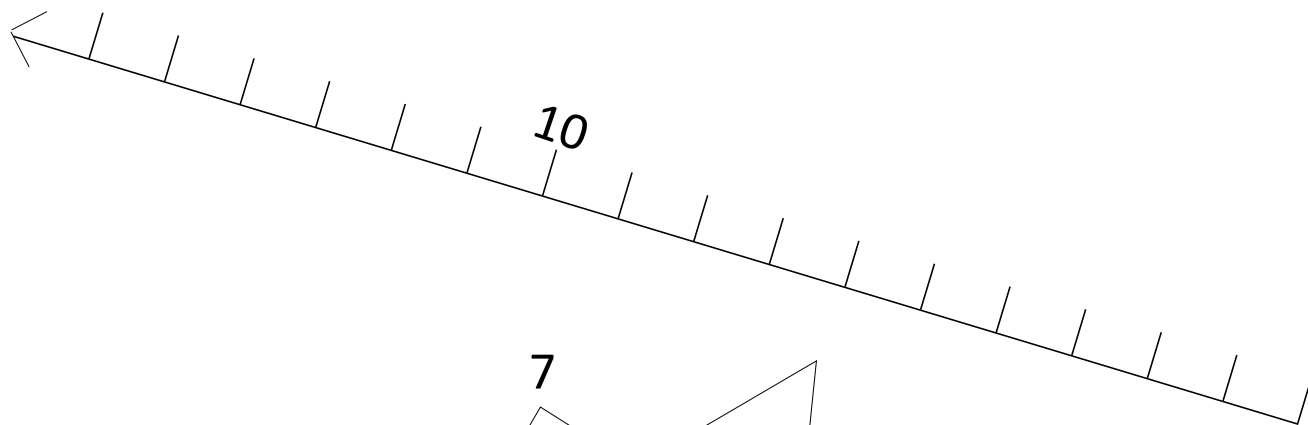
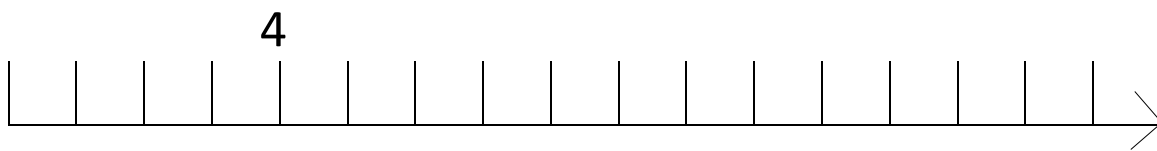

Les nombres jusqu'à 15

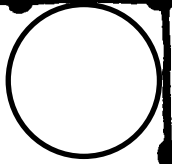

Relie chaque nombre et à ses schèmes (doigts et dés).

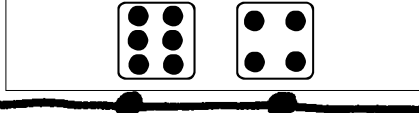
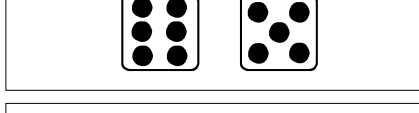
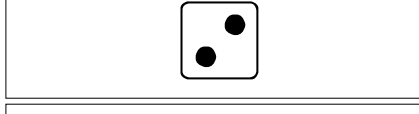
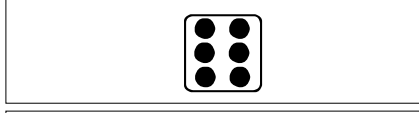
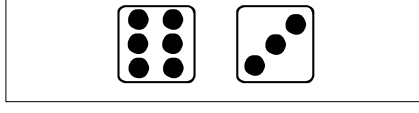
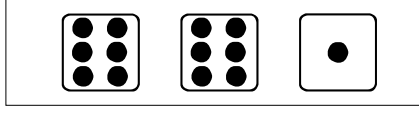
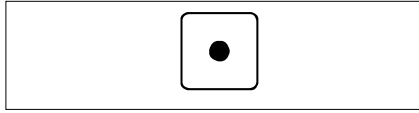
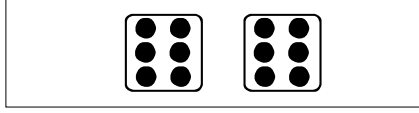
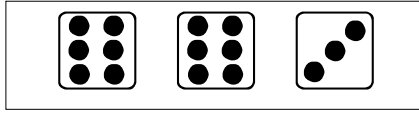
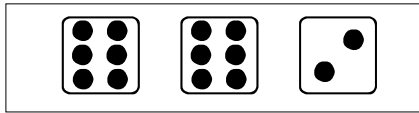
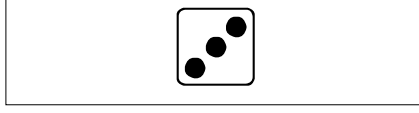
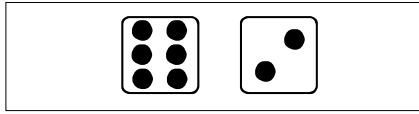
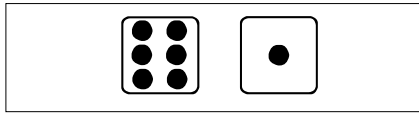
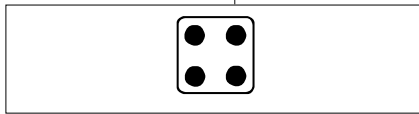

1

2

3

4

5

6

7

8

9

10

11

12

13

14

15

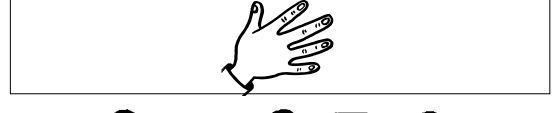
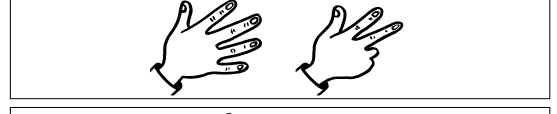
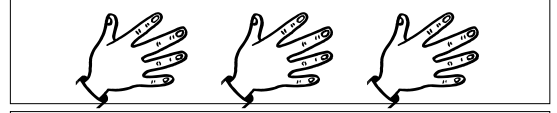
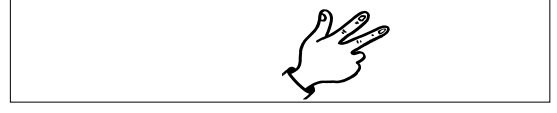
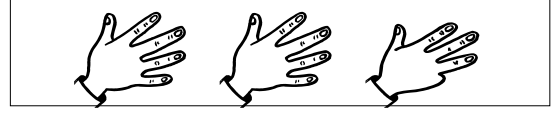
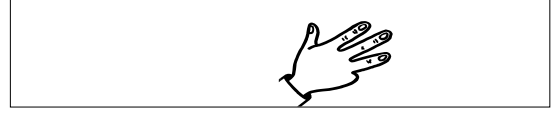
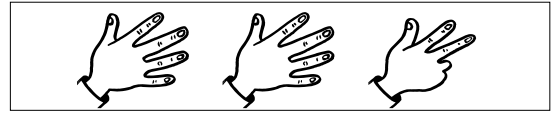
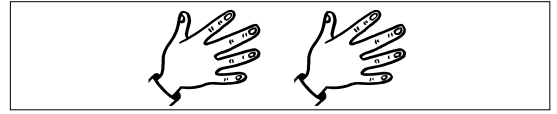
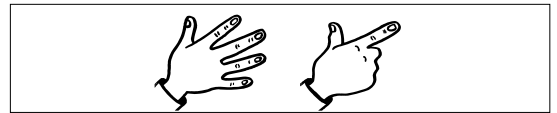
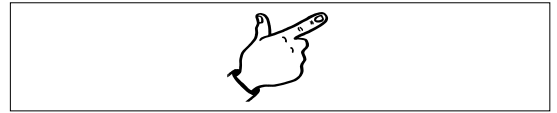
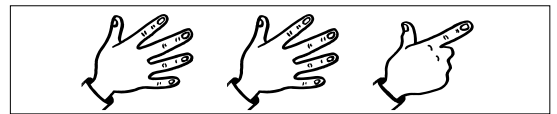
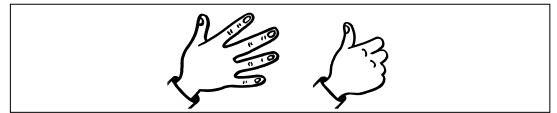
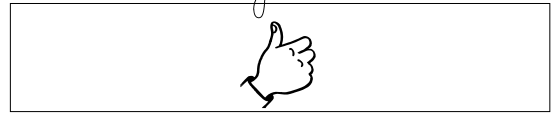

Les nombres jusqu'à 15

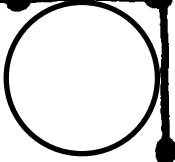

Colorie autant de jetons qu'il y a d'élèves.

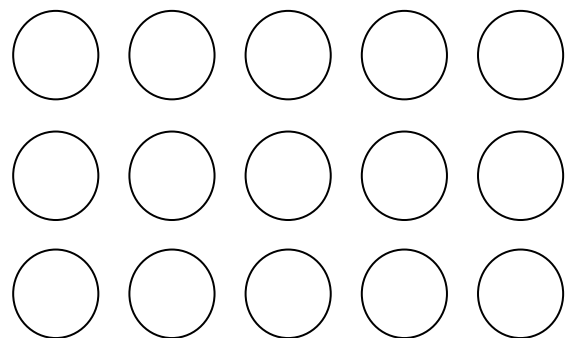
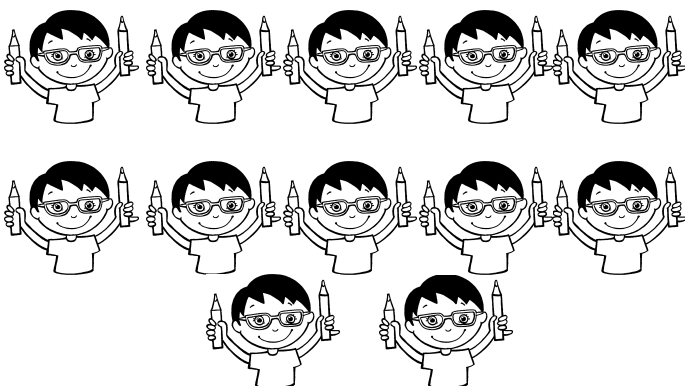
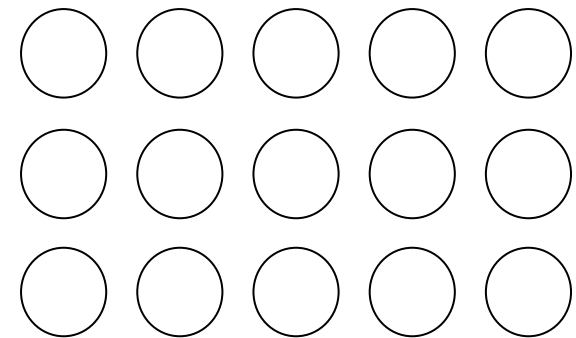
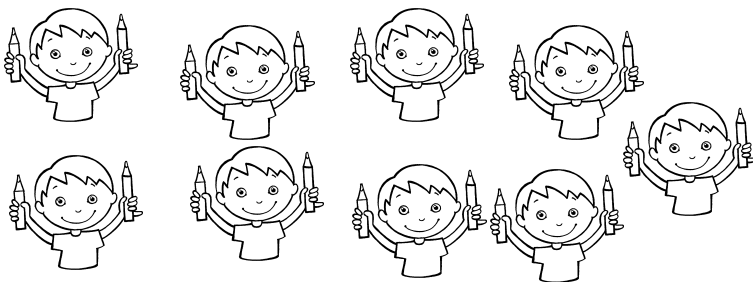
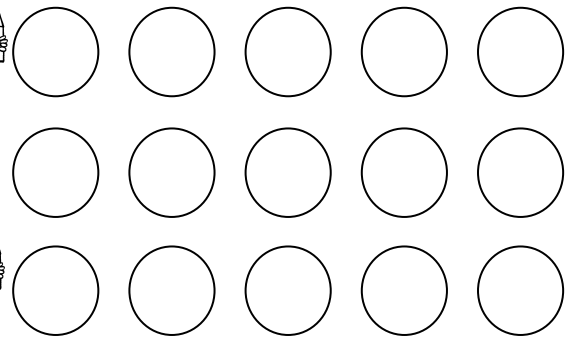
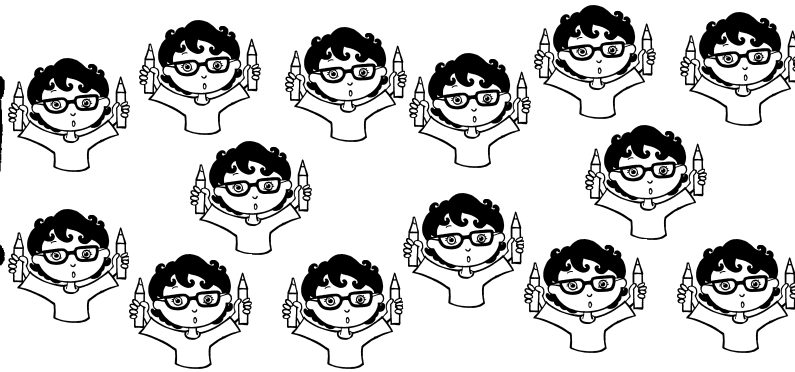
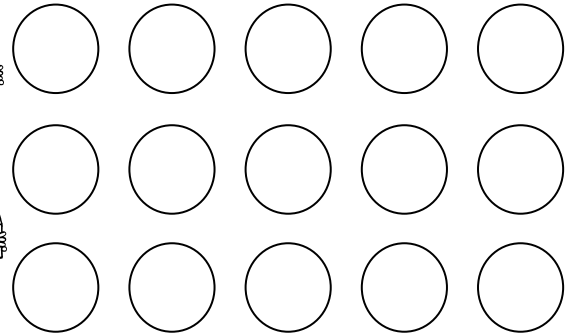
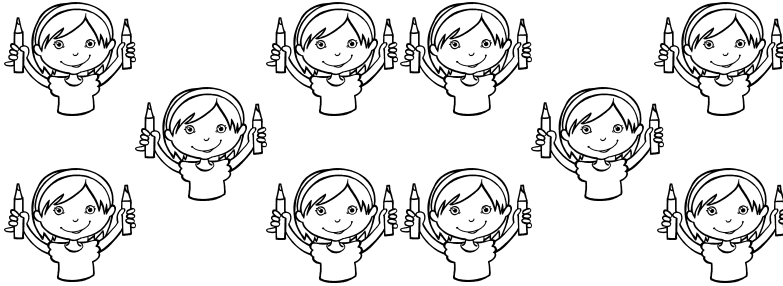

Les nombres jusqu'à 15

Colorie la collection et son étiquette de la même couleur.

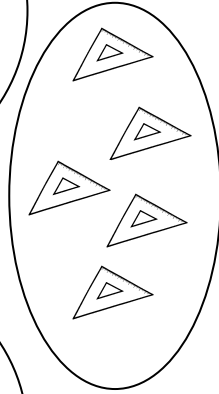
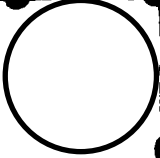

- 1
- 2
- 3
- 4
- 5
- 6
- 7
- 8
- 9
- 10
- 11
- 12
- 13
- 14
- 15

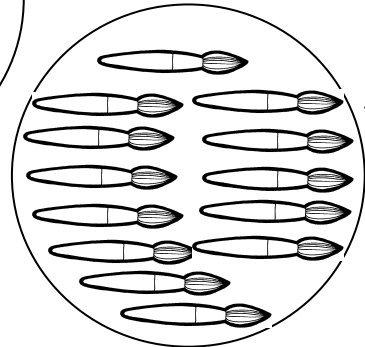
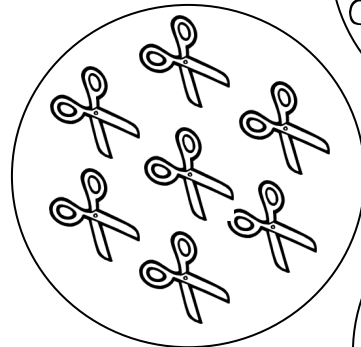
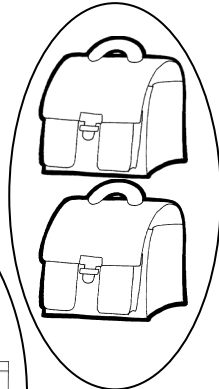
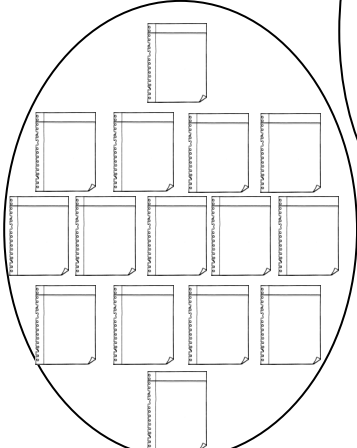
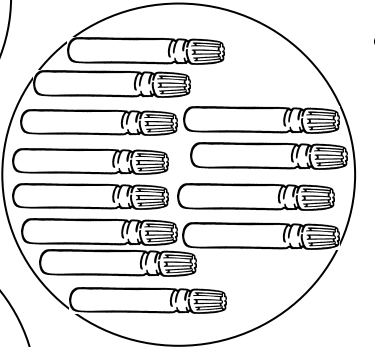
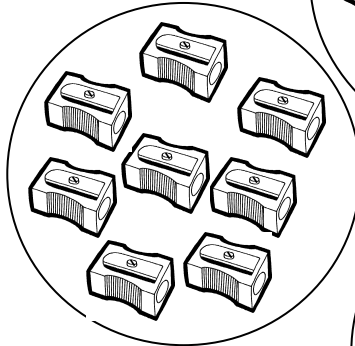
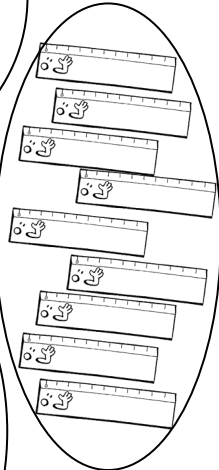
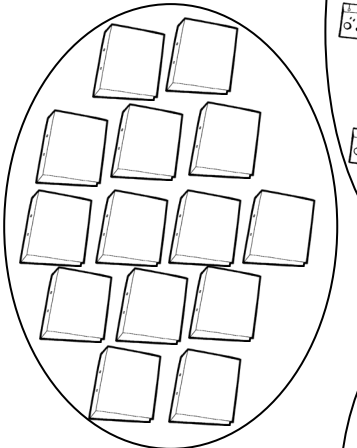
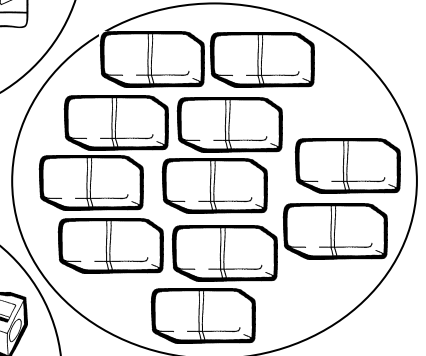
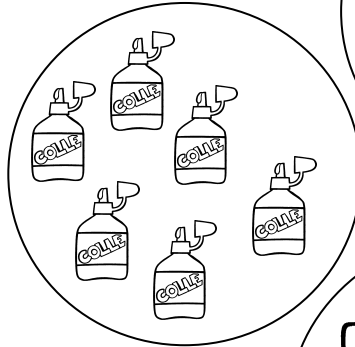
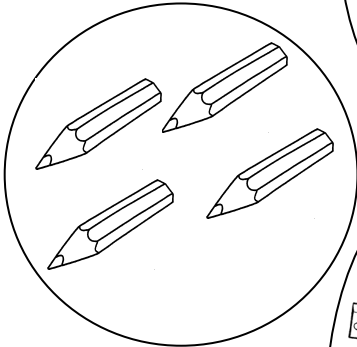
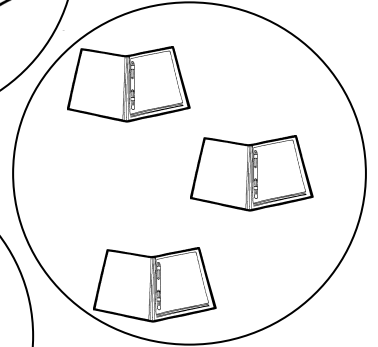
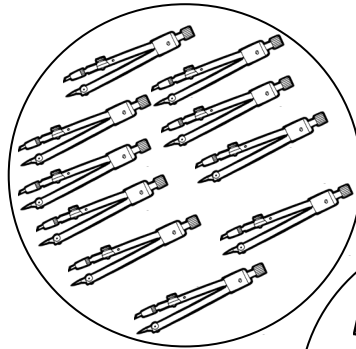

Les nombres jusqu'à 15

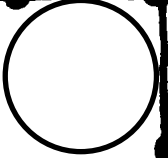

Choisis entre $>$ $<$ $=$

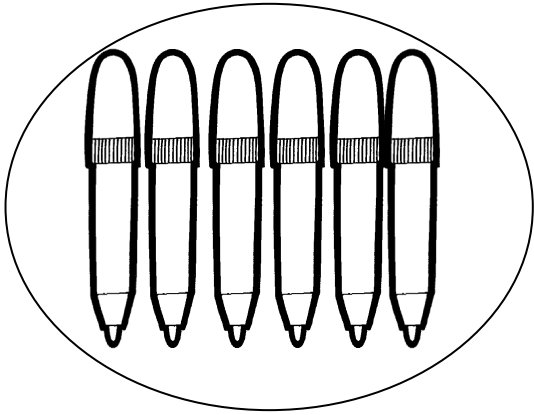

...

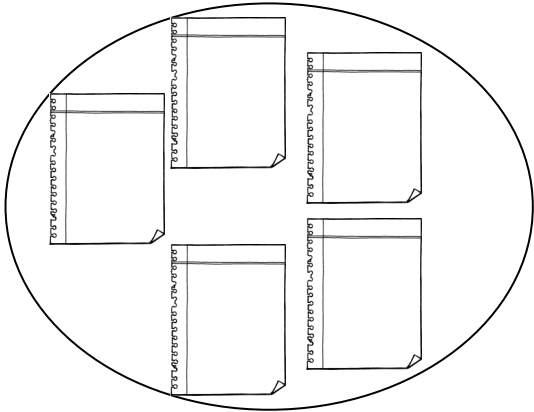
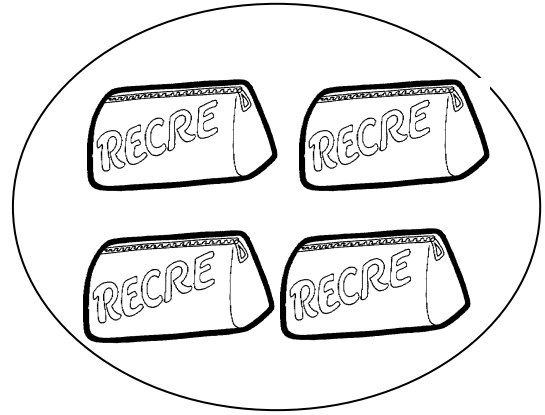

...

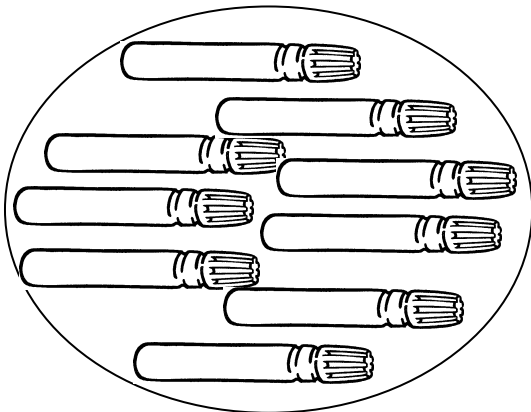
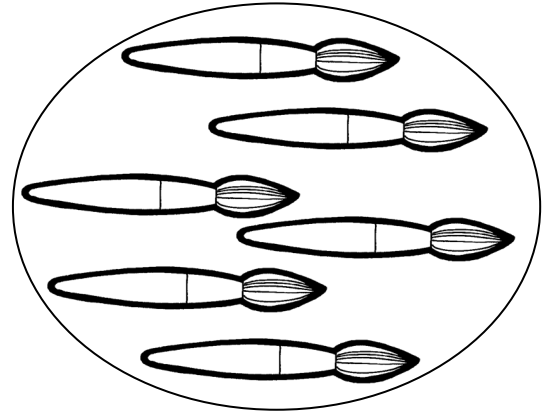

...

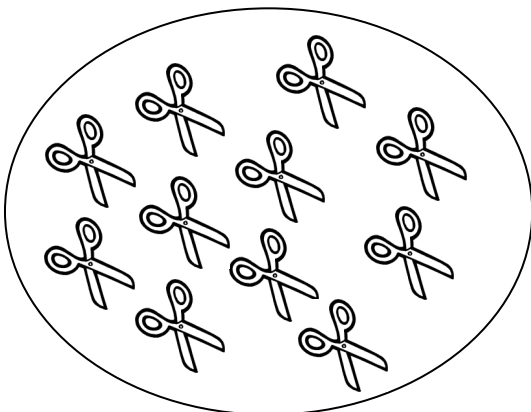
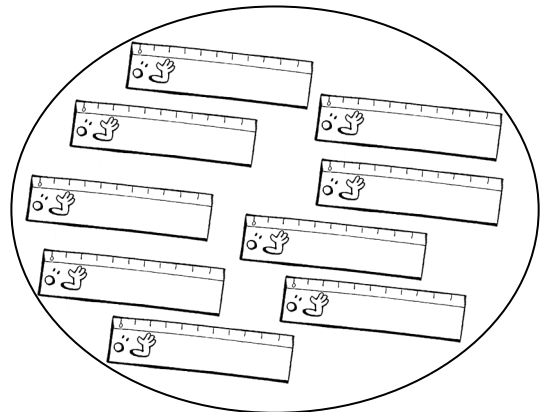

...

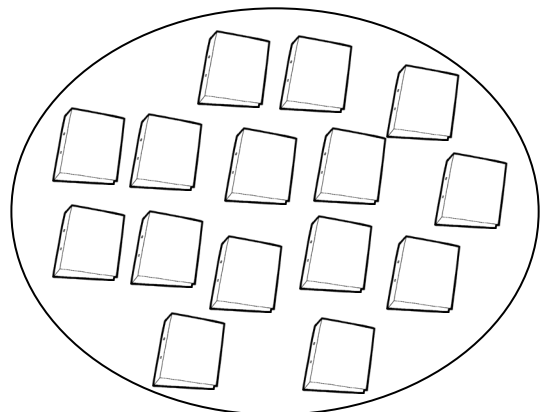

Les nombres jusqu'à 15

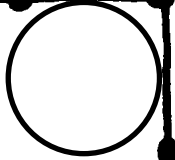

Choisis entre $>$ $<$ $=$

10 ... 11

0 ... 10

10 ... 2

4 ... 3

15 ... 13

10 ... 7

15 ... 7

14 ... 14

1 ... 15

5 ... 15

5 ... 9

15 ... 12

12 ... 10

8 ... 7

15 ... 15

Pour les plus rapides...

10 ... 15

6 ... 11

10 ... 1

4 ... 8

9 ... 8

14 ... 13

15 ... 7

1 ... 14

5 ... 4

5 ... 15

12 ... 9

1 ... 0